



staron[®]

Solid Surfaces

KITCHEN & BATHROOM
COLLECTION

STARON.UK.COM



A STUNNING RANGE OF 30 DÉCORS, TO GIVE YOU SIMPLY AMAZING KITCHEN, BEDROOM AND BATHROOM WORKSURFACES.

Use the Swatch Collection booklet to help you choose the right décor for your design. Then ask your Staron specialist to show you an actual sample to confirm your choice.

staron[®]
Solid Surfaces



SANDED ONYX SO 423



WHY CHOOSE STARON®?

STARON® SOLID SURFACES
ARE 100% WATERPROOF,
HYGIENIC AND DURABLE.
NOT ONLY THAT, THEY HAVE
INVISIBLE JOINTS WHICH CREATE
A UNIQUELY SEAMLESS DESIGN.

TEMPEST POLAR FP 111



SUPREME LOAM VL 155





staron[®]
Solid Surfaces

WHAT IS STARON[®]?

Staron is a sophisticated blend of natural minerals and thermosetting acrylic polymers which has been safely developed for use in the home.

Staron is a solid surface. This means the surface colour runs right the way through the thickness of the material, so that cut outs, drainer grooves and edge profiles can be formed seamlessly.

Separate sections of Staron can be brought together with inconspicuous joints, which also remain 100% waterproof. Perfect for the laundry and bathroom.

Staron has won many awards for being an easily cleaned and hygienically safe surface on which to prepare food. Perfect for the kitchen.

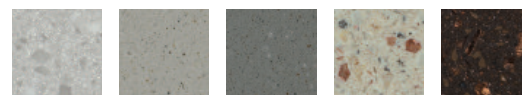



STARON® CAN BE
EASILY RESTORED
TO LOOK AS
GOOD AS NEW,
WHATEVER THE
KIDS THROW AT IT!



SUPREME DAWN VD 126

EASY TO MAINTAIN AND DURABLE

Maintaining Staron solid surfaces could not be easier. Whether in the kitchen or bathroom, the stain resistant durability of Staron means that a damp cloth and mild detergent is all that is needed to deal with everyday spills and to keep your surfaces looking great. Because Staron is 100% waterproof, harmful germs cannot be absorbed into the surface. And because it has smooth invisible seams, there are no joint gaps for dangerous bacteria to develop.

Staron surfaces are tough, but in the unlikely event your surfaces become damaged, Staron offers the peace of mind that it can be easily restored to look as good as the day it was first installed.

Contact your Staron specialist or see our care guide for more information on how to look after your solid surfaces.

staron®
Solid Surfaces

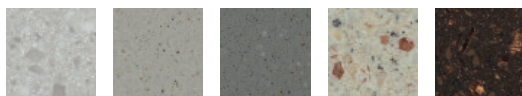

BE INSPIRED

Hobs and sinks can be easily incorporated into the Staron surface design, wherever you want them.

This remarkable image shows how Staron can be thermoformed into stylish gentle curves or more acute radii, without losing any of its strength and durability. Consider having a worksurface that curves downwards at the end of a cabinet to form a seamless gable end.

Or how about a worksurface that curves upwards as it approaches the sink and drainer area, so that the sink is positioned at an easier working height for your back.

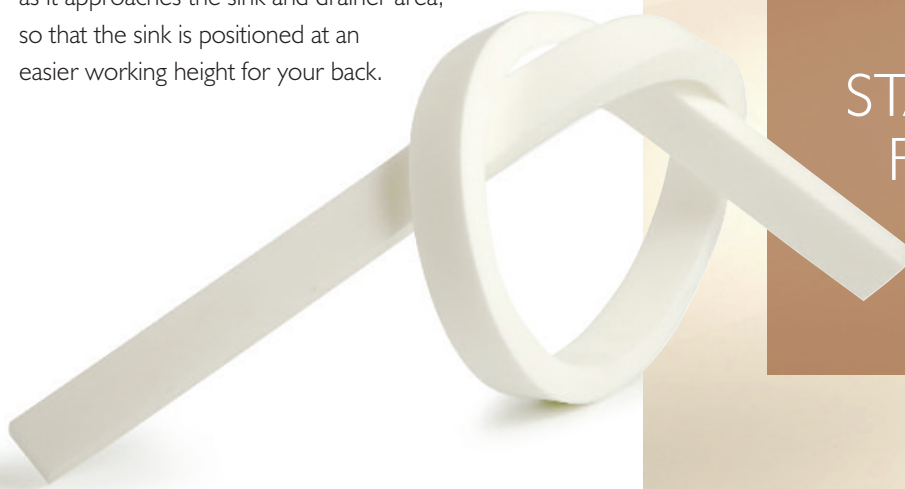

STARON'S DESIGN
FLEXIBILITY WILL
FIRE YOUR
CREATIVITY



NOT JUST SKIN DEEP!

Staron's composition means that all décors are solid throughout the material and not just skin deep! This opens the way for exciting profiles, motifs and drainer grooves to be incorporated into the surface. The unique bonding system does away with unsightly joints and elegantly creates the impression of a surface carved from a single block of stone. The result is a one-piece look for your kitchen or bathroom.





STARON'S CHIC
EFFECTS MAKE
YOUR INTERIORS
UNIQUELY STYLISH

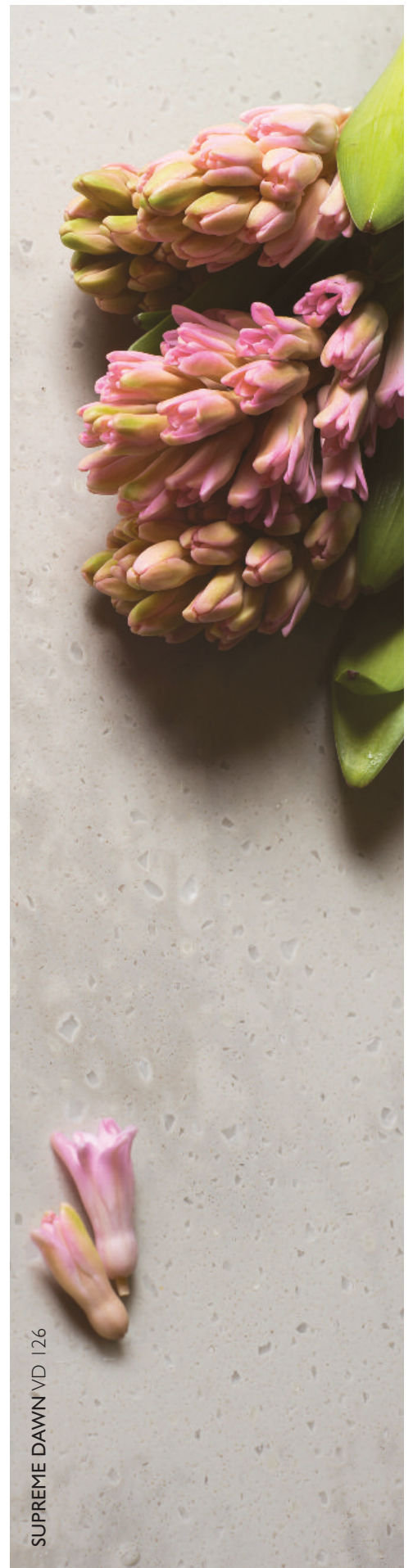

SUPREME DAWN V D 126



SEAMLESS INTEGRATION

Simple and classy, Staron sinks and bowls integrate elegantly with your kitchen or bathroom surfaces. Invisible seams create a perfect fit, without the rims or crevices of other surfaces that can promote the growth of bacteria. The naturally flowing appearance is not only beautiful, but also hygienic, completely waterproof and easy to clean. Cast or thermoformed, the sinks and bowls are non-porous and germ-resistant. Put simply, they are a visually striking and fully functional addition to your home. And you can add drainer grooves that have for example a chevron design or a parallel design.

TURN TO PAGE 24 TO VIEW THE RANGE OF STARON SINKS AND BOWLS.



STARON® IS
A BEAUTIFUL
AND PRACTICAL
SOLUTION FOR
YOUR HOME

A photograph of a kitchen countertop. On the left, a gas stove with black burners is visible. To the right, a clear glass vase holds several red and yellow roses. The countertop is a light, neutral color, and the background is a plain wall. A semi-transparent pink box is overlaid on the left side of the image, containing white text.

STARON® IS AN
ENVIRONMENTALLY
SOUND PRODUCT



STARON[®] AND THE ENVIRONMENT

Staron is helping the environment by removing the need to select natural granites and marbles, which are being extracted wholesale from the Earth.

Staron's recycled range holds the SCS Material Content Certification which verifies that Staron is working responsibly to minimise environmental impact during its manufacturing process.

Staron's capacity to be repaired in the unlikely event of damage caused by a serious impact is also a real environmental benefit. Alternative surfacing materials that have been damaged cannot be repaired and are then often wastefully scrapped.



TEMPEST GLIMMER FG 144

staron®
Solid Surfaces



PEBBLE SARATOGA PS 820

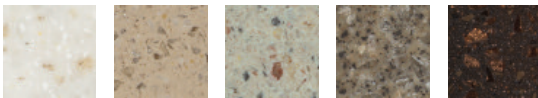

STUNNING BATHROOMS

With their non-porous quality, Staron's bowls and solid surfaces find a natural home in the bathroom. Impervious to moisture, Staron provides smooth, grout-free surfaces, which can be seamlessly integrated with the range of classically designed Staron bowl designs. Stylish, yet functional, Staron creates a stunning look that is easy to clean, hygienic and reassuringly safe for you and your family.





STARON® HAS
ALWAYS FOUND
A NATURAL HOME
IN THE BATHROOM



STARON® GIVES
YOU THE FREEDOM
TO CREATE YOUR
OWN UNIQUELY
SEAMLESS DESIGN



WATERFALL LIP (NON DRIP EDGE)



SINGLE IMPERIAL



DOUBLE CHAMFER (BEVEL)



SINGLE ROUND



DOUBLE ROUND



THIN SURFACE WITH CHAMFER (BEVEL)

COMPLETE THE LOOK

UPSTANDS AND SPLASHBACKS

Matching upstands and splashbacks are the perfect way to protect your walls and complete a sleek seamless look within your kitchen, laundry or bathroom. They are also a more hygienic and modern alternative to the grouted joints of traditional tiles.

EDGING PROFILE OPTIONS

Shown left are a few of the many edge profile options available for your Staron worksurface. You can even come up with your own design.

Talk to your Staron specialist for more details.



QUARRY MINETTE QM 289



GO THICK OR THIN!

When you choose Staron you can also choose the thickness of your worksurfaces with the help of your kitchen designer. From fashionably thin up to whatever thickness you want. You can even stylishly incorporate a mixture of thicknesses into your kitchen design. How about an ultra thick 100mm surface on the breakfast bar and ultra thin 12mm for all the other worksurfaces?

And of course with Staron, you can seamlessly have whatever length or depth of worksurface or breakfast bar you want.

STARON® OFFERS YOU
OPTIONS FOR THE
THICKNESS OF YOUR
WORKSURFACE
AND BREAKFAST BAR

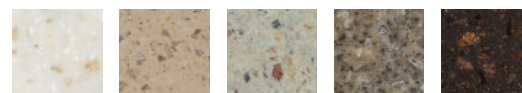

STARON® SOLID SURFACES HOMEOWNER WARRANTY

We are confident in the quality of Staron solid surface products. To ensure your satisfaction, Staron is proud to offer a 15-year limited warranty for homeowners. It's your assurance that your Staron worksurface will maintain its long-term value.

The warranty is also transferable, so you'll be able to pass it along when you sell your home. Please refer to the 'How to Care for your Solid Surfaces' leaflet for full details of the homeowner warranty.

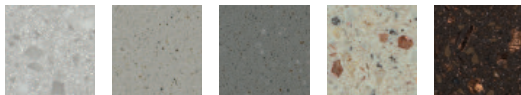

PEBBLE GREY | PG 810

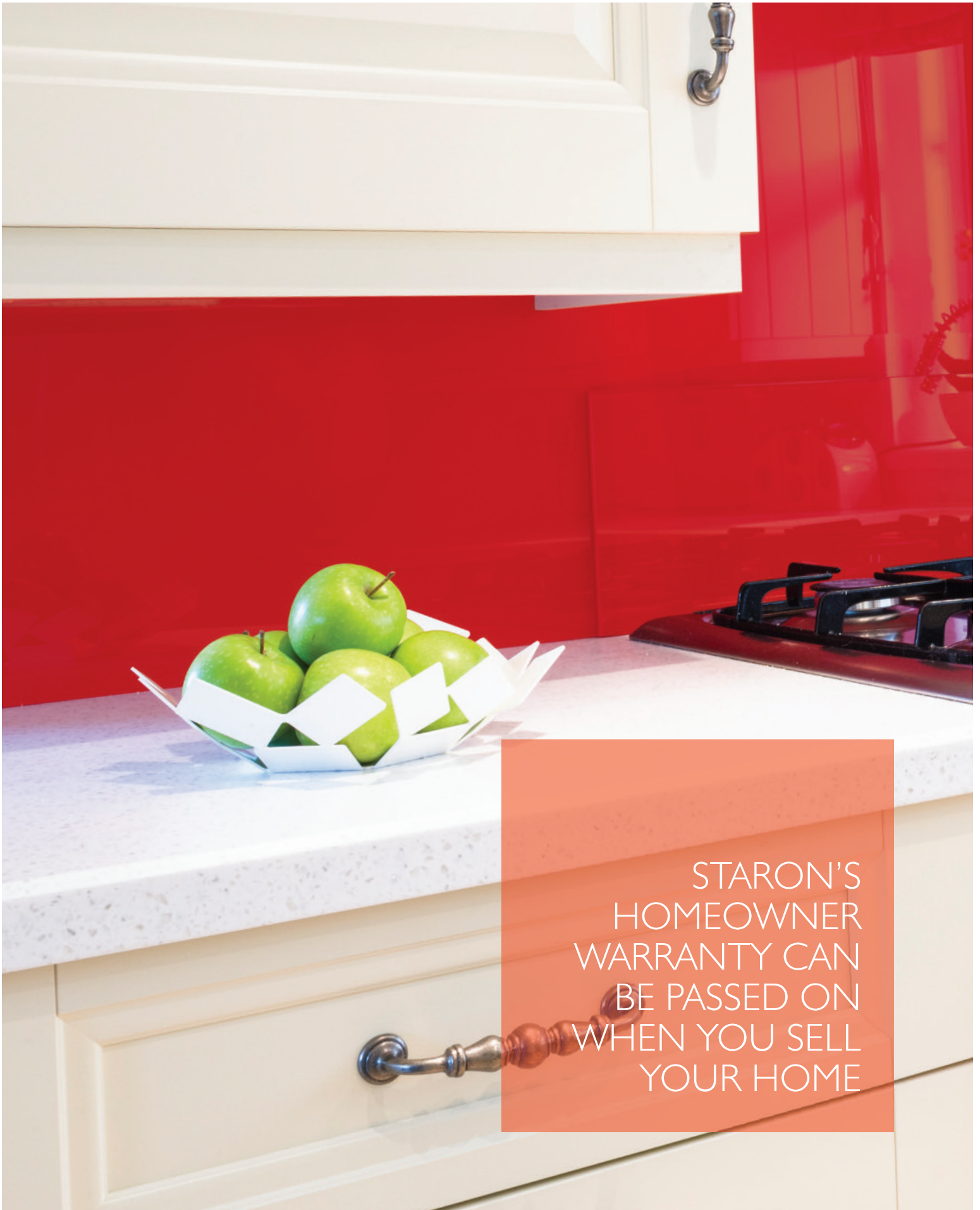

STARON'S
HOMEOWNER
WARRANTY CAN
BE PASSED ON
WHEN YOU SELL
YOUR HOME



SUPREME DANDELION VD 175



SINKS AND BOWLS

THE FOLLOWING RANGE OF SOLID SURFACE SINKS
AND BOWLS ARE NON-POROUS AND WILL
PERFECTLY COMPLEMENT THE STARON® DÉCORS

SOLID SURFACE SINKS AND BOWLS

The solid surface sinks and bowls fully integrate and have no open joints or seams when installed into Staron solid surfaces. This means you have a completely hygienic and easy to maintain surface and sink or bowl which flow together giving you a sensational look.

MOUNTING OPTIONS

SEAM MOUNT

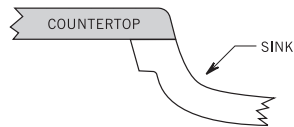

UNDERMOUNT

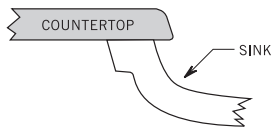

ANGLED MOUNT

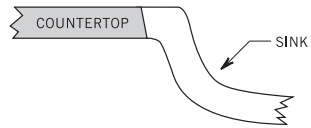

A1121
Bright White

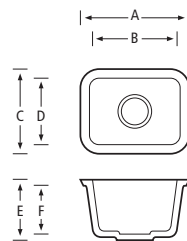

A	416mm	D	266mm
B	356mm	E	180mm
C	326mm	F	165mm



A1181
Bright White

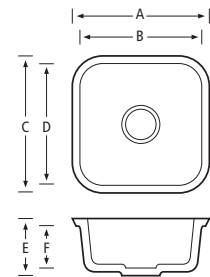

A	460mm	D	400mm
B	400mm	E	225mm
C	460mm	F	208mm



A1231
Bright White

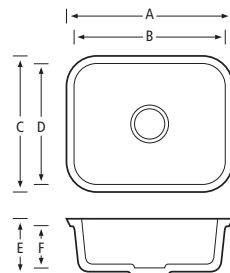

A	592mm	D	422mm
B	532mm	E	202mm
C	482mm	F	187mm



A3181
Bright White

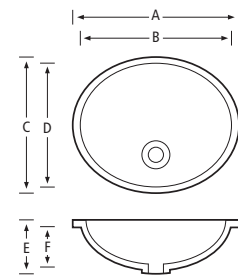

A	462mm	D	336mm
B	422mm	E	156mm
C	376mm	F	139mm

CAST SINKS AND BOWLS



A1131
Bright White

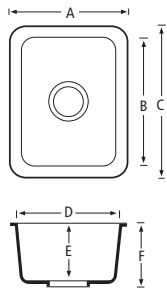

A 341mm	D 281mm
B 400mm	E 133mm
C 460mm	F 148mm



A2341
Bright White

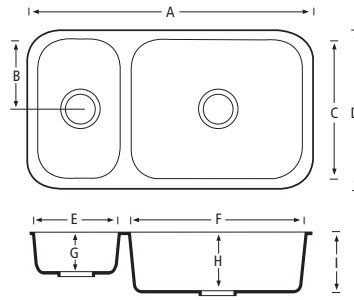

A 886mm	F 533mm
B 213mm	G 127mm
C 426mm	H 191mm
D 486mm	I 206mm
E 254mm	



A2311
Bright White

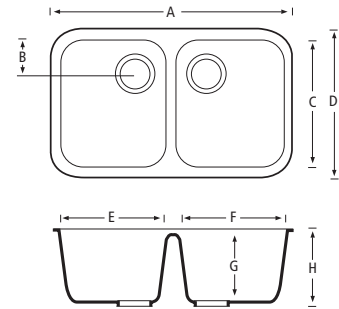

A 794mm	E 348mm
B 110mm	F 348mm
C 421mm	G 235mm
D 481mm	H 250mm



A3211
Bright White

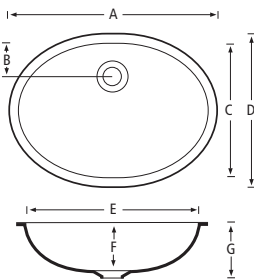

A 548mm	E 508mm
B 66mm	F 156mm
C 356mm	G 173mm
D 396mm	



A3201
Bright White

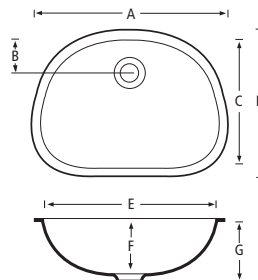

A 517mm	E 477mm
B 86mm	F 140mm
C 346mm	G 157mm
D 386mm	

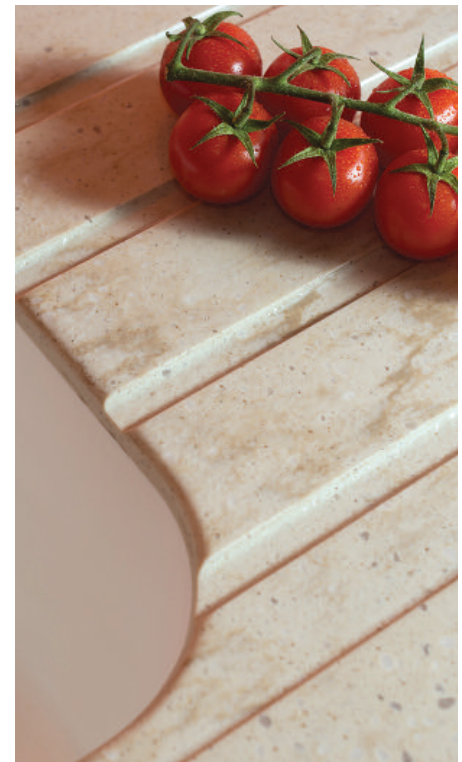

Drainer grooves can be graduated within the solid surface from 2mm – 5mm to create a water fall that drains away drips and splashes.

SINKS AND BOWLS WITH STAINLESS STEEL BASES



CTK0162

Base Options:
Colour Matched / Stainless Steel

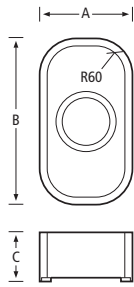

- A 162mm
- B 300mm
- C 95mm



CTK0375

Base Options:
Colour Matched / Stainless Steel

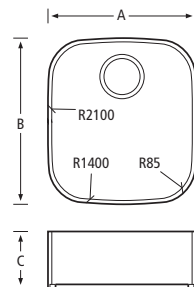

- A 375mm
- B 420mm
- C 150mm



CTK0332

Base Options:
Colour Matched / Stainless Steel

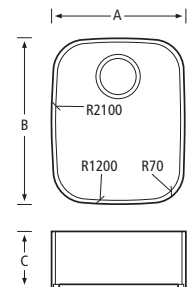

- A 332mm
- B 418mm
- C 150mm



CTK0400

Base Options:
Colour Matched / Stainless Steel

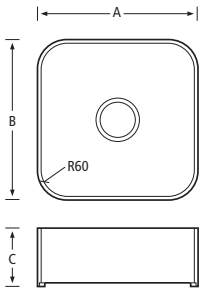

- A 400mm
- B 400mm
- C 150mm



CTK0450

Base Options:
Colour Matched / Stainless Steel

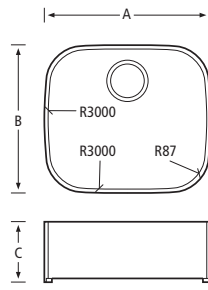

- A 450mm
- B 400mm
- C 150mm



CTK0495

Base Options:
Colour Matched / Stainless Steel

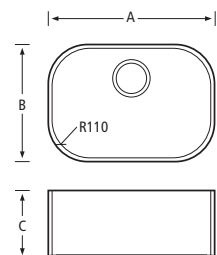

- A 495mm
- B 345mm
- C 150mm



CTK0550

Base Options:
Colour Matched / Stainless Steel

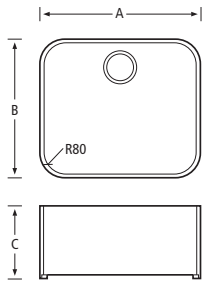

- A 162mm
- B 300mm
- C 95mm



TK0199

Base Options:
Colour Matched / Stainless Steel

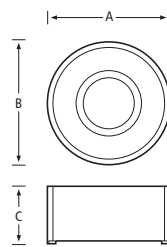

- A 199mm
- B 199mm
- C 100mm



TK0385

Base Options:
Colour Matched / Stainless Steel

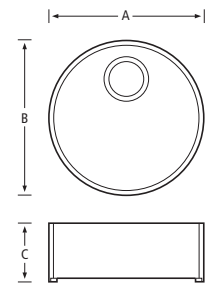

- A 385mm
- B 385mm
- C 150mm



SPECIALLY ORDERED SINKS AND BOWLS

Staron sinks and bowls can also be formed using any of the Staron décors available in the UK and Ireland.

These specially ordered sinks can either colour match or contrast with the surrounding Staron surfaces into which they can be seamlessly installed.

STAINLESS STEEL UNDERMOUNT SINKS



ESK
0.5 bowl / Stainless Steel

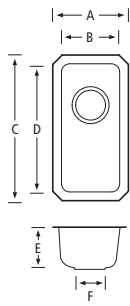

A	230mm	D	400mm
B	180mm	E	124mm
C	450mm	F	90mm



WEAVER
1.0 bowl / Stainless Steel

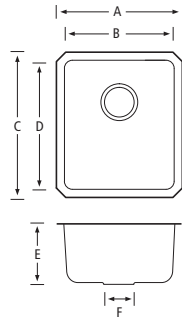

A	390mm	D	400mm
B	340mm	E	195mm
C	450mm	F	90mm



TWISS
1.0 bowl / Stainless Steel

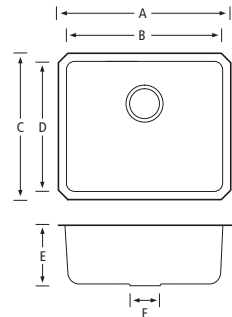

A	530mm	D	400mm
B	480mm	E	200mm
C	450mm	F	90mm



The high grade 18/10 stainless steel of these undermount sinks ensures a quality finish and long term corrosion resistance.



BRETT
1.5 bowl / Stainless Steel

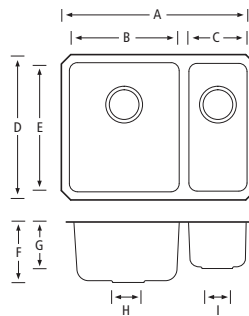

A	600mm	F	184mm
B	340mm	G	124mm
C	180mm	H	90mm
D	450mm	I	90mm
E	400mm		



TRENT
1.5 bowl / Stainless Steel

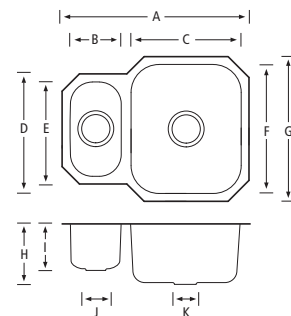

A	594mm	G	460mm
B	164mm	H	185mm
C	350mm	I	114mm
D	300mm	J	90mm
E	350mm	K	90mm
F	410mm		



COLNE

1.5 bowl / Stainless Steel

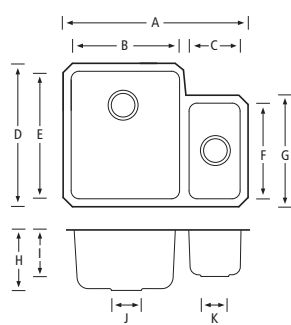

A	580mm	G	300mm
B	340mm	H	190mm
C	160mm	I	120mm
D	450mm	J	90mm
E	400mm	K	90mm
F	250mm		



DERWENT

1.5 bowl / Stainless Steel

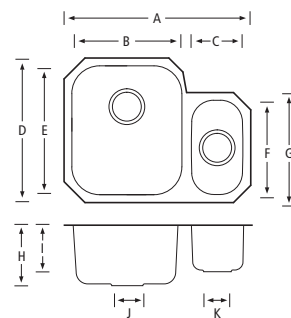

A	594mm	G	350mm
B	350mm	H	189mm
C	164mm	I	114mm
D	460mm	J	90mm
E	410mm	K	90mm
F	300mm		



THE DÉCOR COLLECTION

Please refer to our Swatch Collection booklet for larger examples of each décor.

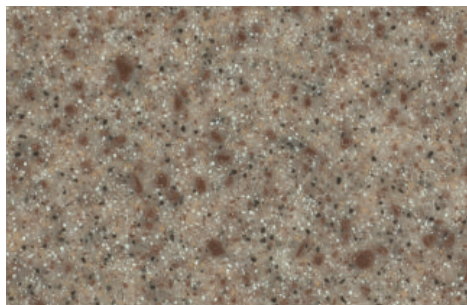

ASPEN BROWN / AB 632

SCS B

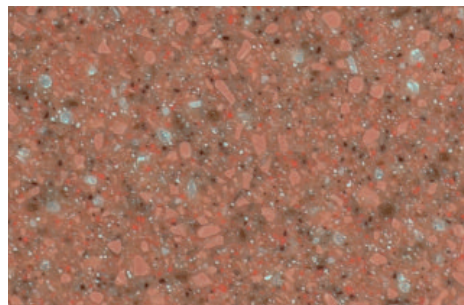

ASPEN LAVA / AL 650

B ❖

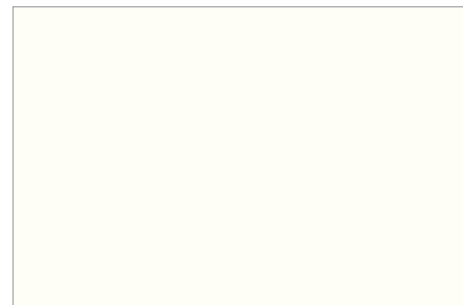

BRIGHT WHITE / BW 010

C

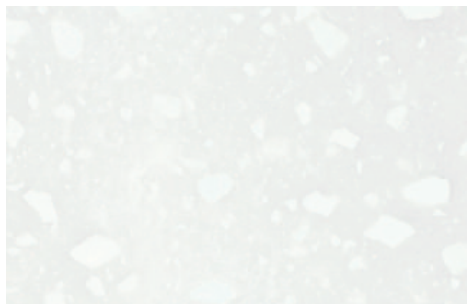

PEBBLE ICE / PI 811

C



PEBBLE SWAN / PS 813

C



PEBBLE SARATOGA / PS 820

SCS C

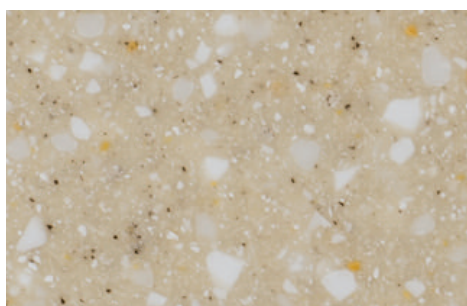

PEBBLE GOLD / PG 840

SCS C

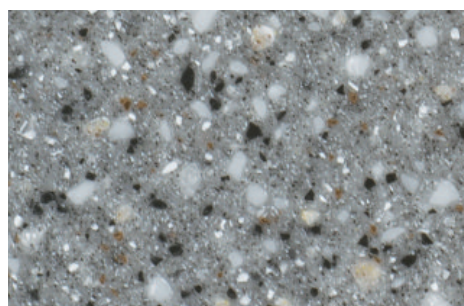

PEBBLE GREY / PG 810

C



QUARRY OYSTER / TO 310

SCS C

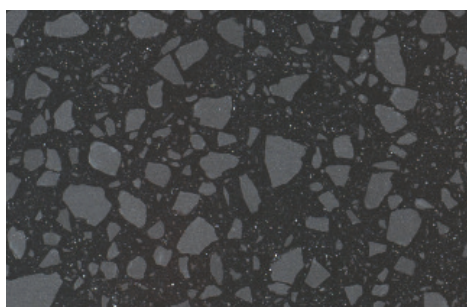

QUARRY MINETTE / QM 289

B ❖ ❖



SANDED VERMILLION / SV 430

B

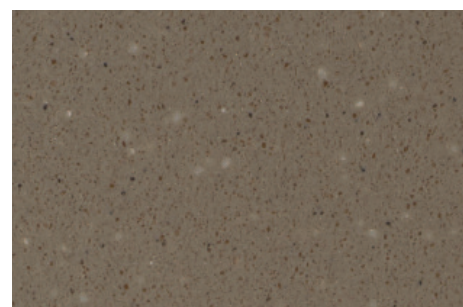

SANDED CLAY / SC 475

B

ENVIRONMENTALLY SOUND



Staron's recycled range holds the SCS Material Content Certification which verifies that Staron is working responsibly to minimise environmental impact during its manufacturing process. Staron's capacity to be repaired in the unlikely event of damage caused by a serious impact is an environmental benefit. Alternative surfacing materials that have been damaged cannot be repaired and are then often wastefully scrapped.

staron[®]
Solid Surfaces

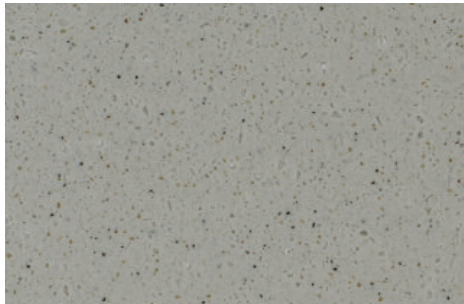

SANDED HERON / SH 428

B

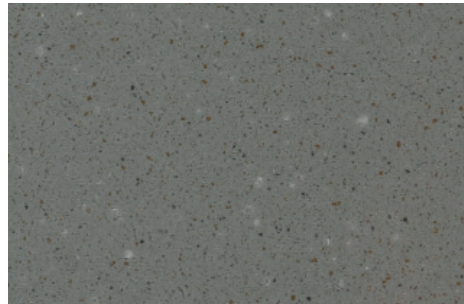

SANDED TUNDRA / ST 482

C ❖

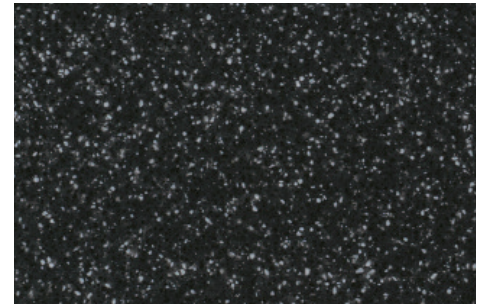

SANDED DARK NEBULA / DN 421

SCS C ❖



SANDED ONYX / SO 423

SCS B ❖



TEMPEST POLAR / FP 111

C

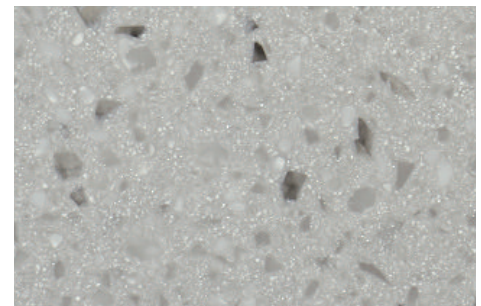

TEMPEST SILVERCLOUD / FS 122

C

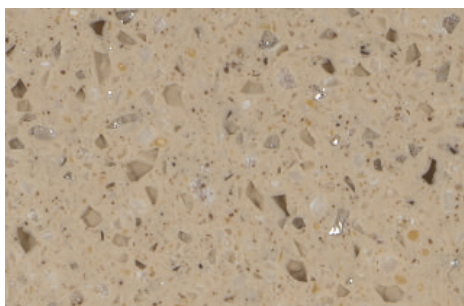

TEMPEST GENESIS / FG 174

C

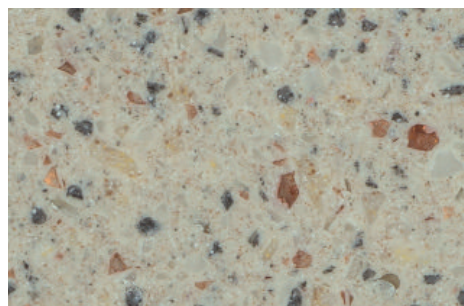

TEMPEST GLIMMER / FG 144

C

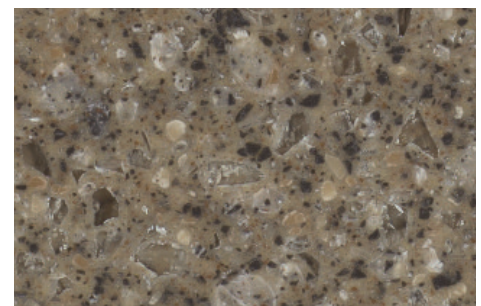

TEMPEST WHIPPOORWILL / FW 145

C ❖

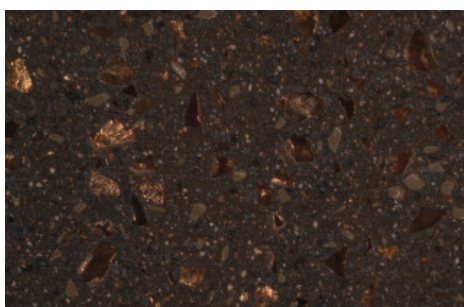

TEMPEST BLAZE / FB 147

C ❖

SCS These colours hold the SCS Material Content Certification which verifies that Staron is working responsibly to minimise environmental impact during its manufacturing process.

B European fire retardant certificate B1 (DIN 4102-1 & DIN EN 1350-1)

C European fire retardant certificate C (DIN 4102-1 & DIN EN 1350-1)

- ❖ Dark colours and high gloss finishes – Staron is a durable and repairable solid surface that will last for many years with simple care. Please refer to our maintenance guidance leaflet. Dark colours and high gloss finishes will, like everything else, potentially show scratches if a worktop saver has not been used. Scratches or abrasions marks are not covered under the Staron 15 year limited warranty. However, if scratches occur over a period of time, the surface can be re-sanded and re-finished, which will remove the scratches. Refinishing your surface must be performed by an authorised Staron fabricator / installer and you will be charged at an hourly service rate.
- ❖ Contains metallic flakes that have reflective properties, which may cause the colour to look different (brightness) depending on the angle of view.

Whilst every effort has been made to accurately represent the décors within this brochure, we are unable to guarantee an exact match due to the limitations of the printing process. Please view actual sample prior to selection.

Before you install your Staron surface, please verify that batch numbers are the same to ensure a complete colour match.

MORE DÉCORS OVER THE PAGE...

STARON.UK.COM

THE DÉCOR COLLECTION

These larger décor images will help your selection by displaying the variation of the pattern over a 3680mm length. Please refer to our Swatch Collection booklet for larger examples of each décor.

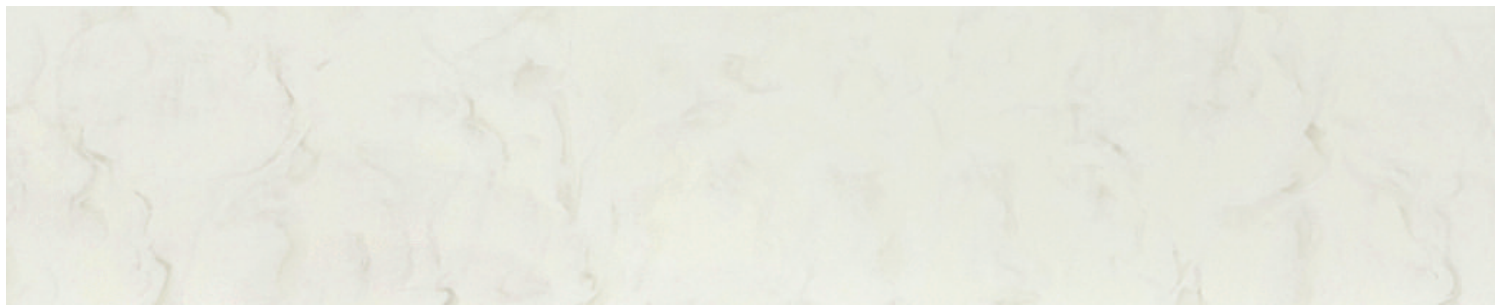

SUPREME DELPHI / VD 111



SUPREME DAWN / VD 126

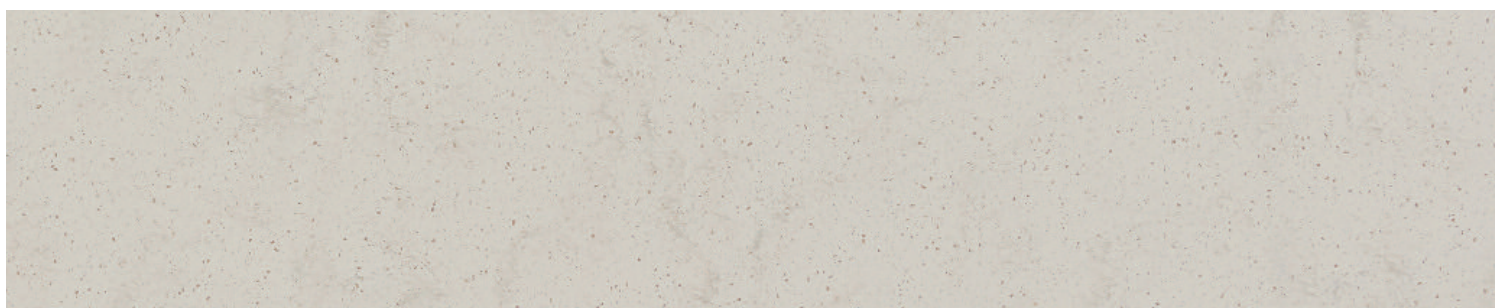

SUPREME NATURAL BRIDGE / VN 144



SUPREME PASTORAL / VP 177



☐ European fire retardant certificate C (DIN 4102-1 & DIN EN 1350-1)

❖ Dark colours and high gloss finishes – Staron is a durable and repairable solid surface that will last for many years with simple care. Please refer to our maintenance guidance leaflet. Dark colours and high gloss finishes will, like everything else, potentially show scratches if a worktop saver has not been used. Scratches or abrasions marks are not covered under the Staron 15 year limited warranty. However, if scratches occur over a period of time, the surface can be re-sanded and re-finished, which will remove the scratches. Refinishing your surface must be performed by an authorised Staron fabricator / installer and you will be charged at an hourly service rate.

Whilst every effort has been made to accurately represent the décors within this brochure, we are unable to guarantee an exact match due to the limitations of the printing process. Please view actual sample prior to selection.

Before you install your Staron surface, please verify that batch numbers are the same to ensure a complete colour match.

Supreme



SUPREME CLOUDBANK / VC 118

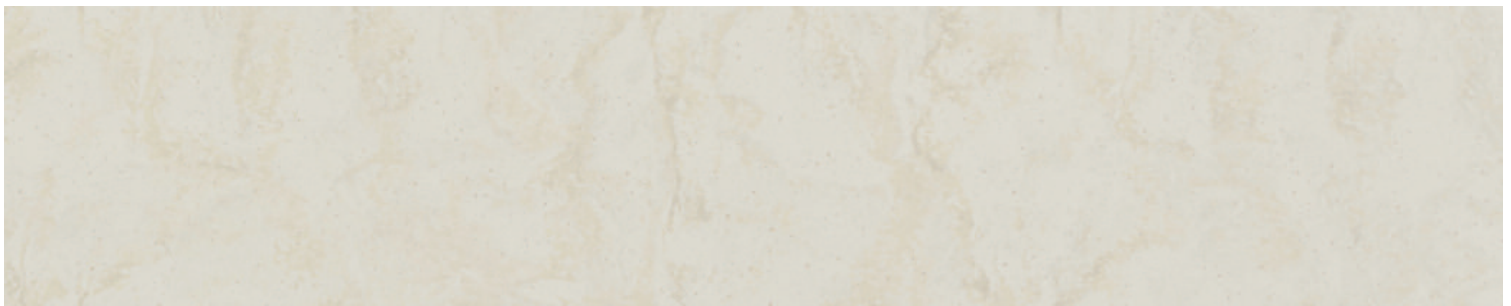

SUPREME MAGNOLIA / VM 143



SUPREME DANDELION / VD 175

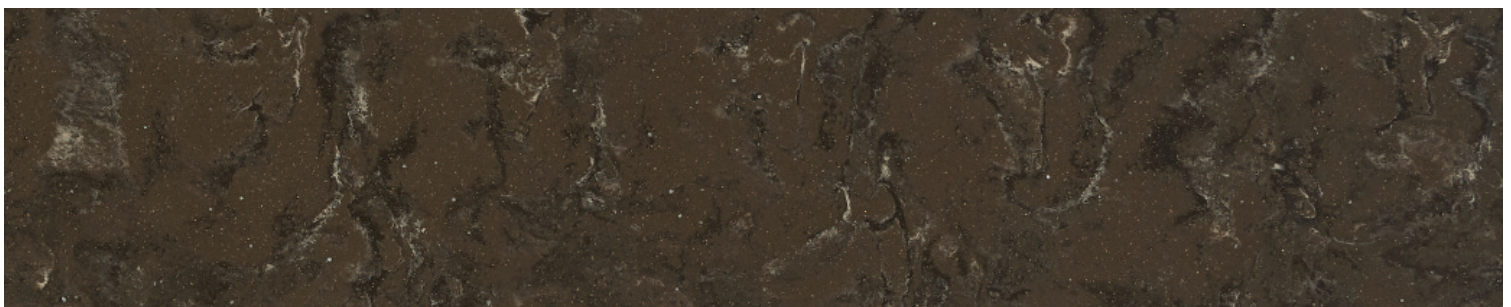

SUPREME LOAM / VL 155





staron[®]
Solid Surfaces

**BLACKHEATH PRODUCTS LIMITED
EXCLUSIVE UK AND IRELAND
STARON DISTRIBUTOR**

Units 1-4 Fairfield Park,
Halesowen, West Midlands B62 9JL

Free 24 hour faxline: +44 (0)800 634 0114

Telephone: +44 (0)121 561 4245

Email: sheets@blackheathproducts.co.uk

www.staron.uk.com

All dimensions shown are nominal. We reserve the right to update specifications without notice. E&OE.